

**PLEASE READ AND UNDERSTAND ALL SECTIONS IN THIS MANUAL BEFORE YOU BEGIN YOUR INSTALLATION.**

For additional information please visit [inhausurfaces.com](http://inhausurfaces.com) or call 1.888.255.3412.



**WARNING! DO NOT SAND, DRY SWEEP, DRY SCRAPE, DRILL, SAW, BEADBLAST OR MECHANICALLY CHIP OR PULVERIZE EXISTING RESILIENT FLOORING, BACKING, LINING FELT, ASPHALTIC “CUTBACK” ADHESIVES OR OTHER ADHESIVES.**

These products may contain asbestos fibers and/or crystalline silica. Avoid creating dust. Inhalation of such dust is a cancer and respiratory tract hazard. Smoking by individuals exposed to asbestos fibers greatly increases the risk of serious bodily harm. Unless positively certain that the product to be removed is a non-asbestos containing material, you must presume it contains asbestos. Regulations may require that the material be tested to determine asbestos content. See current edition of the Resilient Floor Covering Institute (RFCI) publication, “Recommended Work Practices for Removal of Resilient Floor Coverings” for detailed information and instructions on removing all resilient covering structures. For current information, go to [www.rfci.com](http://www.rfci.com).

**WARNING:**

Drilling, sawing, sanding or machining wood products can expose you to wood dust, a substance known to the State of California to cause cancer. Avoid inhaling wood dust or use a dust mask or other safeguards for personal protection. For more information go to [www.P65Warnings.ca.gov/wood](http://www.P65Warnings.ca.gov/wood).

**CAUTION:**

- Use a dust mask, safety glasses and gloves when cutting Lamdura Manor flooring.
- If using power tools to cut planks, always cut in a well-ventilated area.
- Never use tools designed for other flooring installation systems (eg. seam rollers, tap blocks, etc.).
- Never wax, polish or use abrasive cleaners on Lamdura Manor floors as they may damage the floor's finish beyond repair.
- This product is a floating floor. It should not be nailed/screwed to subfloor or in anyway pinned to the subfloor by the installation of furniture or cabinets.

**NOTE:** If excessive moisture accumulates in buildings or on building materials, mold and/or mildew growth can occur. Care should be taken to address any moisture related issues prior to installing Lamdura Manor.



## VIDEO INSTRUCTIONS

A comprehensive video is available on our website to guide you through the entire installation process. Scan the QR to learn more.

## INTENDED USE

Lamdura Manor floors are intended for indoor use only and can be installed in any room without in-floor drainage. Lamdura Manor laminate floors are intended for residential and limited commercial applications. Read these instructions fully before installation to understand the specific steps and determine the suitability for your application.

# LAMDURA MANOR HERRINGBONE FLOORING INSTALLATION INSTRUCTIONS

## HANDLING

- Handle Lamdura Manor with care prior to installation; protect carton edges, do not drop cartons, etc.
- Always store Lamdura Manor cartons flat and properly supported on a level surface.
- Never lean cartons against walls and do not store them on saw-horses or similar equipment that does not fully support the full length of the cartons.

## TOOLS & MATERIALS

- Electric saw
- Clamps
- Multitool
- Chalk line
- Level
- Utility knife
- Glue
- Spacer blocks
- Moisture resistant tape
- Square
- Ruler
- Pencil
- Spade bit and drill
- Underlayment
- Vapor barrier (if installing over concrete subfloor):
  - 100% flexible neutral curing silicone caulking
  - Polyethylene (PE) backer rod

## PRE-INSTALLATION

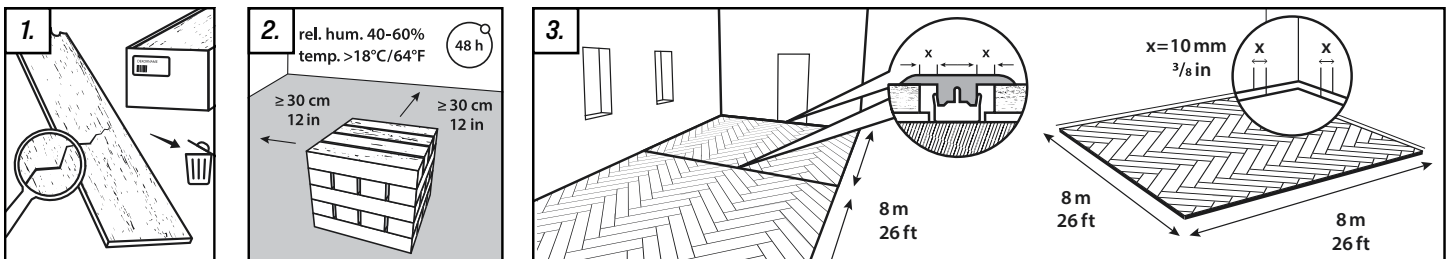

### 1. EXAMINE PLANKS

Check all planks for color against samples used in selection to ensure correct product. Further, inspect for defects and transportation damage. Any planks that show damage or defects should not be used.

### 2. ACCLIMATION

Best practices require 48 hours to acclimate Lamdura Manor to the conditions of the installation area. To acclimate: cross-stack unopened cartons in the installation area and at room temperature approx. 64°F-73°F (18°C-23°C).

### 3. TRANSITIONS

It is recommended that transitions (T-Moldings) be used to separate rooms. If using transitions, ensure the necessary expansion space is left between Lamdura Manor planks and the vertical section of the T-Molding.

#### EXPANSION SPACE

It is necessary to leave a 3/8" (10mm) expansion space around the perimeter of the room and all other objects (e.g. toe kicks, plumbing, etc.). The expansion space will be covered by the wall base or quarter round once the floor is installed. *If installing in moisture prone areas, please refer to the Recommendations for Wet Area Installation section of this guide.*

#### MAXIMUM ROOM SIZE

Lamdura Manor floors can be installed in a single room up to 676 ft<sup>2</sup> (62 m<sup>2</sup>) and/or 26 linear feet (8 m) in length or width. Installations in rooms that are over 26 linear feet (8 m) in length and overlaps to adjacent rooms should use expansion joints to divide the floor sections.

## PRE-INSTALLATION CONTINUED

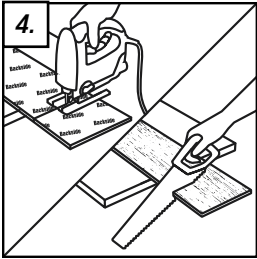

### 4. CUTTING PLANKS

Lamdura Manor flooring planks are designed to be cut with guillotine-type flooring cutters and power saws (e.g. circular saw, table saw, miter saw, jigsaw) as well as hand saws. It is important to use good quality, sharp blades in order to minimize damage to the planks; however, small chips along the cuts will be hidden by the wall base or trim.

**NOTE:** Lamdura Manor planks should always be cut in a separate room/area in order to minimize debris and dust in the installation site. Always wear protective equipment such as safety glasses, a NIOSH-approved dust mask and gloves.

## SUBFLOOR PREPARATION

Lamdura Manor floors can be installed over many types of subfloors as long as they are properly prepared and meet the required criteria outlined below.

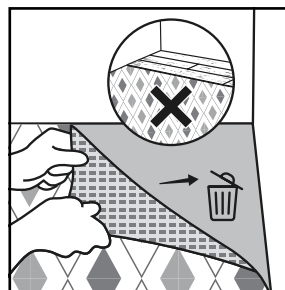
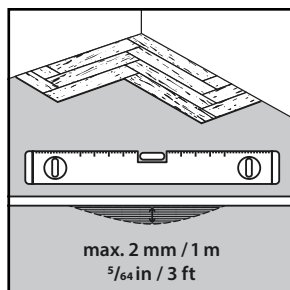
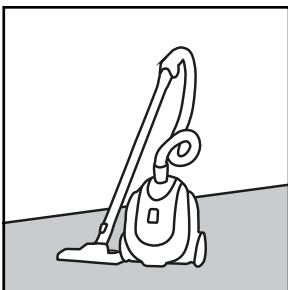

### GENERAL SUBFLOOR PREPARATIONS & PRECAUTIONS

- Subfloors must be clean and free of dirt and debris prior to installation.
- Subfloors must be structurally sound.
- Lamdura Manor floors can be installed in bathrooms, kitchens, and entryways by following the *Recommendations for Wet Area Installations* section of this guide.
- Variations in the subfloor flatness should not exceed 5/64" per 3 ft (2mm per m) or 3/16" in 10 ft (5 mm in 3 m). Floors must be leveled to meet this specification prior to installation. Level by filling depressed areas with floor leveling compounds and grinding down any raised areas.
- Abrupt height differences of more than 3/64" per 4 in. (1mm per 10cm) must be corrected (for example, nail heads, concrete ridges and other similar small protrusions).
- All carpet, carpet pad and carpet tack must be removed prior to installation.
- Care must be taken to ensure that the subfloor meets all local building codes and regulations. If installation is below grade or on grade, foundation walls must meet all local building codes and regulations.
- Crawl spaces must meet all local building codes and regulations. Any moisture or risk of moisture existing in your crawl space should be mitigated prior to installing Lamdura Manor.

## SUBFLOOR PREPARATION CONTINUED

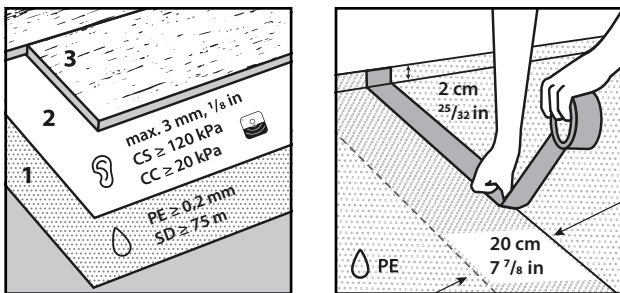

### CONCRETE SUBFLOORS

Concrete subfloors must be properly cured and allowed to dry for at least 60 days prior to installation of Lamdura Manor. Always test concrete subfloor for moisture prior to installation by following these steps:

- Tape 3' x 3' (91cm x 91cm) pieces of polyethylene vapor barrier to subfloor.
- If condensation appears on the film after 24 hours or concrete appears dark in color, moisture is likely present, and a Calcium Chloride test must be performed.

The maximum allowable moisture emission is 5.0 lbs./1000 ft<sup>2</sup> per 24 hours (2.26 kg/100 m<sup>2</sup> per 24 hours) ASTM F1869. Alternatively, a Tramex test can be performed in accordance with ASTM F2659. However, recorded values higher than 4.5% require a Calcium Chloride test to verify that the subfloor moisture is appropriate. In Situ probe testing can also be used according to ASTM F2170 and the reading should not exceed 75%.

- A vapor barrier must be used when installing over concrete.
- If using a 6mil (0.2mm) polyethylene vapor barrier:
  - Overlap vapor barrier edges by 8" (20cm) and seal with moisture resistant adhesive tape.
  - Run vapor barrier 3/4" (2cm) up the wall and install wall base trim over it.

### WOOD SUBFLOORS

- Wood subfloors must be structurally sound and screwed or nailed to supporting beams.
- Subfloor moisture must be tested prior to installation and should not exceed 12% throughout the installation area.
- Do not install Lamdura Manor floors over wood subfloors applied directly to concrete.
- Crawl spaces should be dry and vented as per local building code.

### VINYL (SHEET/TILE), LINOLEUM, CERAMIC TILE

- Existing floor covering must be in good condition with no tears, cracks or chips.
- Floor covering should be well bonded to the subfloor and the surface should be flat and smooth.
- Heavily cushioned floor covering (eg. cushion vinyl) and resilient floors that exceed one layer in thickness should be removed. Follow manufacturer's guidelines when uninstalling resilient floor coverings. Wear personal protection equipment (dust mask, gloves, glasses, etc.).
- If installing over ceramic tile, any abrupt unevenness of more than 3/64" per 4 in. (1mm per 10cm) must be corrected.
- If vinyl, linoleum, or ceramic tile is installed over concrete, a vapor barrier must be installed over it.
- If using a 6mil (0.2mm) polyethylene vapor barrier:
  - Overlap vapor barrier edges by 8" (20cm) and seal with moisture resistant adhesive tape.
  - Run vapor barrier 3/4" (2cm) up the wall and install wall base trim over it.

## SUBFLOOR PREPARATION CONTINUED

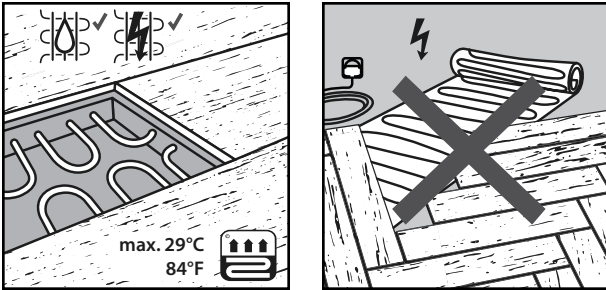

### INSTALLATIONS OVER RADIANT HEATING SYSTEMS

Lamdura Manor flooring can be installed over embedded in-floor heating systems and must have a minimum of 1/2 in. (12mm) separation from the product. Maximum temperature should never exceed 84° F (29° C).

- In-floor heat systems must be operating for a minimum of 3 weeks prior to installation of Lamdura Manor floors.
- Floor heating systems should be applied to the entire area of the installation or separated by transitional moldings.

**Refer to radiant heat system manufacturer's recommendations for additional guidance.**

## ROOM PREPARATION

### WALL BASE /TRIM

- Removal of existing wall base/trim is optional. If you decide not to remove your wall base then, you will have to install quarter-round moldings after installation of your Lamdura Manor floor is complete.
- Wall base or trim will need to be installed once the flooring installation is complete to cover the expansion space around the perimeter of the room.
- Always nail/adhere wall base and trim to the wall. Never nail/adhere it to the flooring.

### CABINETS & ISLANDS

- It is best practice to install cabinets prior to installing Lamdura Manor floors.
- If cabinets need to be installed after Lamdura Manor is installed, they should be mounted to the wall and in a manner that does not pin Lamdura Manor and prevent it from performing as a floating floor.
- Permanent/fixed islands should always be installed prior to installing Lamdura Manor.
- Free-standing kitchen islands can be placed on top of Lamdura Manor floors provided:
  - a. They do not exceed 500 lbs (227 kg).
  - b. They are not fastened to or through Lamdura Manor.
  - c. They do not prevent Lamdura Manor floors from expanding and contracting.

## ROOM PREPARATION CONTINUED

### DOORS & DOOR JAMBS

Lamdura Manor floors should be installed under door jambs. As such door jambs will need to be undercut accordingly. To do so:

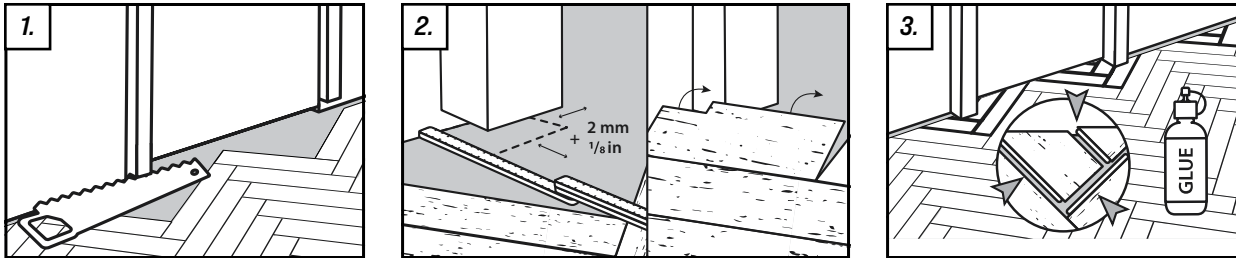

1. Use scrap pieces of Lamdura Manor flooring and underlayment to support your saw blade at the correct height for undercutting.
2. Measure the size of the door frame and cut a plank to size.
3. Install the planks and use glue to hold the locking system together.
  - Check door clearances and make any necessary height adjustments before installing Lamdura Manor floors.
  - Make sure to leave the necessary expansion spacing from the wall under the door jamb.

**TIP: If possible, it is often easiest to start the flooring installation the door of the room so that the first plank can be easily slid under the door jamb.**

- In some cases, you may have to modify a plank's locking system as a door jamb may prevent you from angling it into place. To do so, safely remove the vertical section of the groove. This will allow you to slide planks together horizontally. Apply a small amount of adhesive into the plank's groove and slide the plank into place.

## VAPOR BARRIER & UNDERLAYMENT

Install vapor barrier and/or underlayment as per manufacturers' instructions.

### POLYETHYLENE VAPOUR BARRIER REQUIREMENTS

|  |                        |
|--|------------------------|
| <b>Thickness</b>                         | Minimum 6 mil (0.2 mm) |
| <b>Diffusional resistance (SD-value)</b> | Minimum 75 meter       |

### UNDERLAYMENT REQUIREMENTS

|  |                         |
|--|-------------------------|
| <b>Thickness</b>                       | Maximum 1/8 inch (3 mm) |
| <b>Compressive strength (CS-value)</b> | Minimum 120 kPa         |
| <b>Compressive creep (CC-value)</b>    | Minimum 20 kPa          |

### INSTALLING A VAPOR BARRIER - IF APPLICABLE

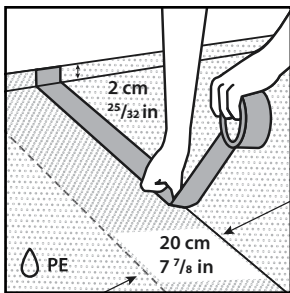

1. Refer to and follow the manufacturer's installation instructions for the correct installation method.
2. If using a 6mil (0.2mm) polyethylene vapor barrier:
  - Overlap vapor barrier edges by 8" (20cm) and seal with moisture resistant adhesive tape.
  - Run vapor barrier 3/4" (2cm) up the wall and install wall base trim over it.
  - Examine the vapor barrier to make sure there are no gaps or wrinkles.

### INSTALLING AN UNDERLAYMENT

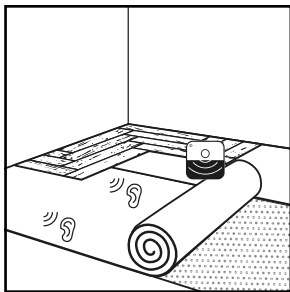

1. Refer to and follow the manufacturer's installation instructions for the correct installation method.
2. Examine the underlayment to make sure there are no gaps or wrinkles.

**CHOOSE YOUR LAYOUT**

When installing herringbone flooring, you have two distinct methods to choose from, each offering a unique aesthetic and pattern. Your choice between these two methods will define the overall look of the space:

**METHOD #1 - DIAGONAL LAYOUT**

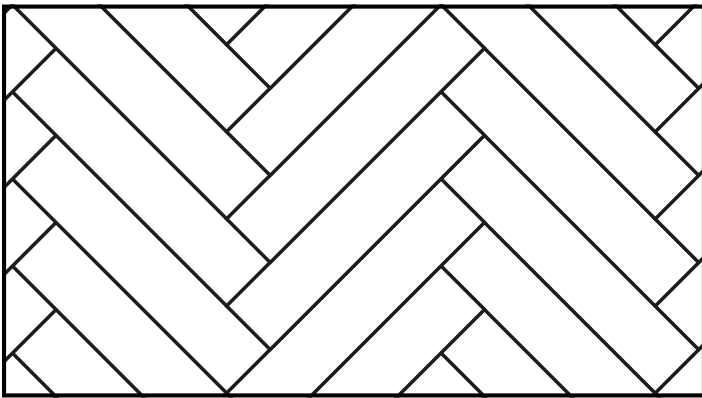

Refer to pages 9-12

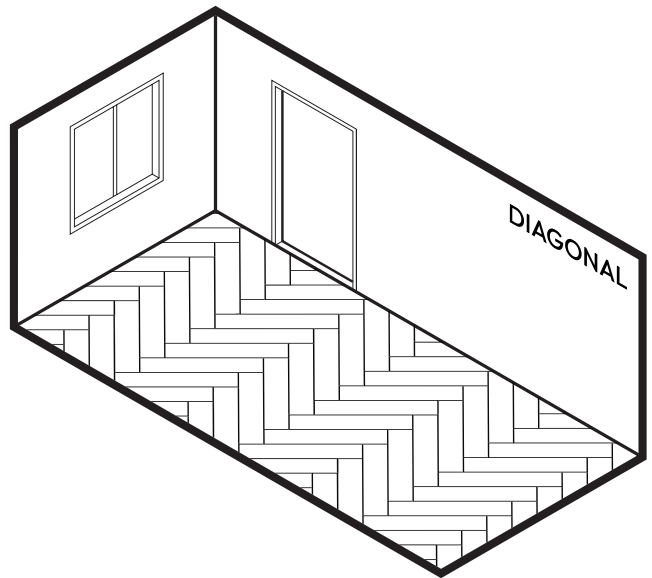

**METHOD #2 - PARALLEL LAYOUT**

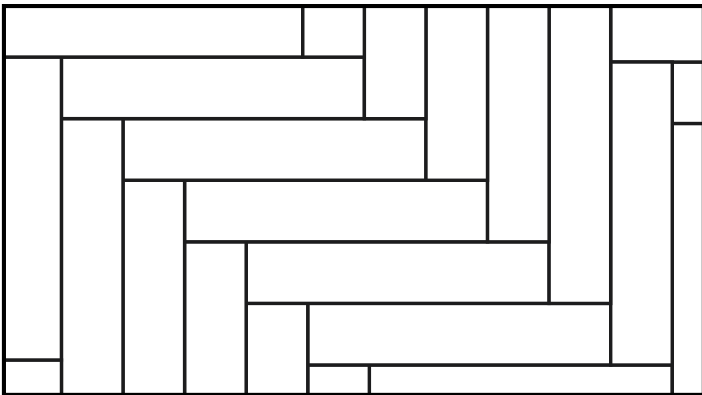

Refer to pages 13 - 14

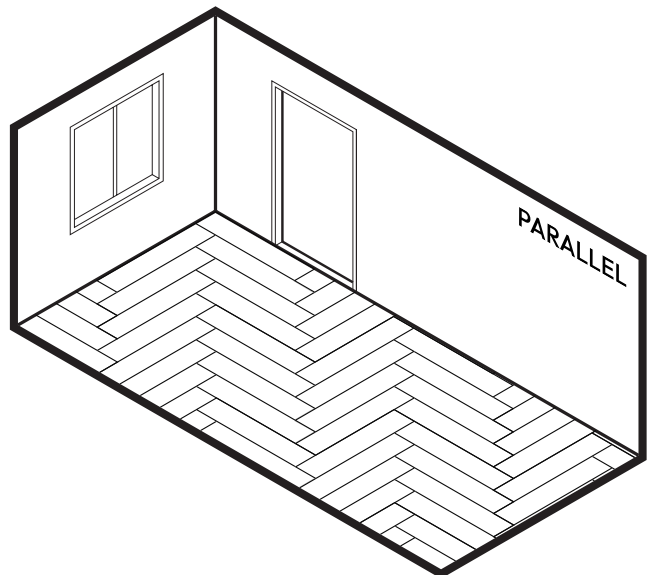



## INSTALLATION PROCEDURE - DIAGONAL LAYOUT

### HOW TO LAY THE FIRST PLANK

#### **⚠ WARNING**

The flooring should be installed with planks from multiple cartons simultaneously, mixing them to achieve a balanced variation in color and shade. Check the planks for any damage prior to installation.

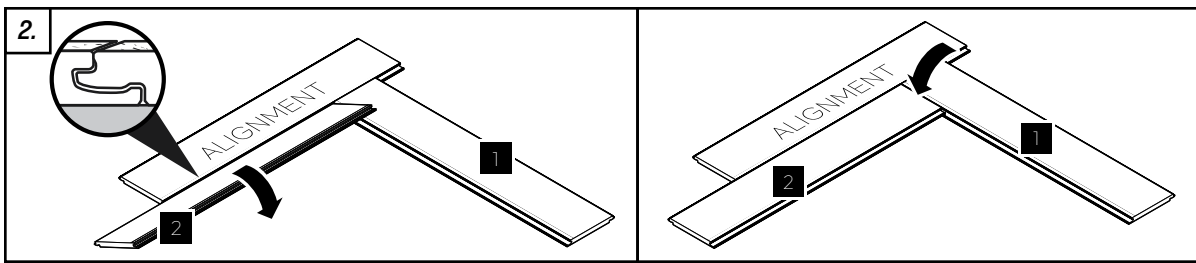
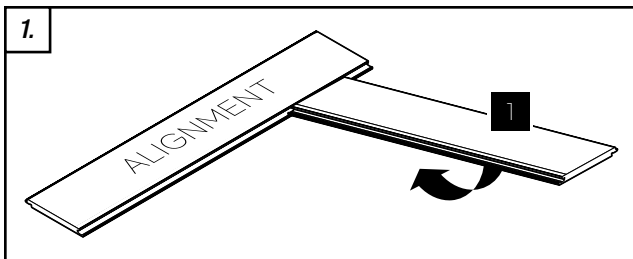

1. Click the first plank into another plank as shown in diagram above.
2. Click a second plank into position. Make sure the plank is properly pushed into the other planks.

### MARK THE STARTING LINE

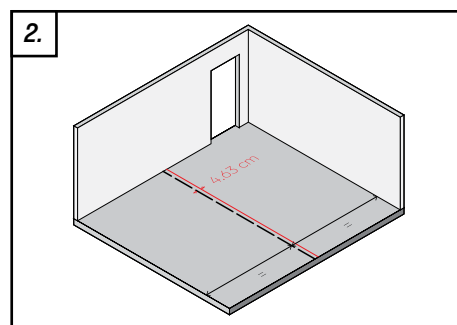
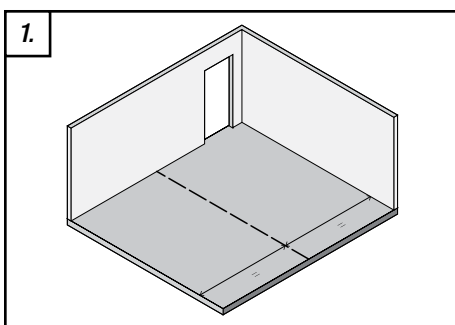

1. Find and mark the center line of the installation area using a chalk line.
2. Mark a new start line perpendicular to the center line, offset by 5cm (2 inches) from the center line.

## INSTALLATION PROCEDURE - DIAGONAL LAYOUT CONTINUED

### HOW TO LAY THE FIRST COLUMN

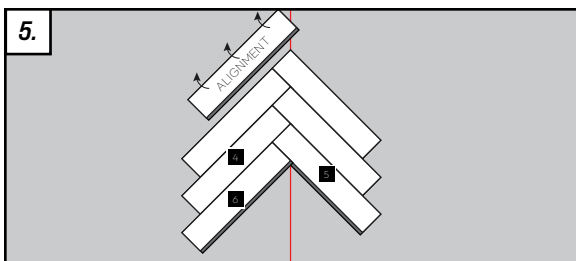
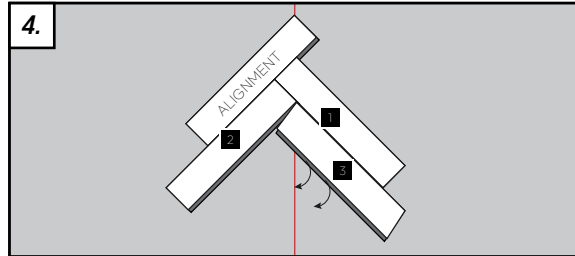
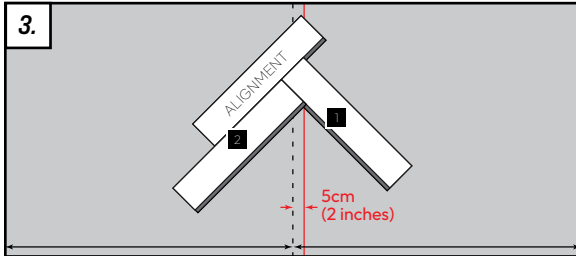

3. Align the planks to the start line, make sure that the point where the planks join is on the start line.
4. Continue building the first column by clicking the planks into position.
5. Remove the alignment plank once the first 6 planks have been installed.

### HOW TO EXPAND THE FIRST COLUMN

#### **⚠ WARNING**

Always leave a  $\frac{3}{8}$  inch (10 mm) expansion gap around the perimeter of the room and all other objects (e.g. toe kicks, plumbing, etc.). Use spacer blocks to make sure the expansion gap is accounted for.

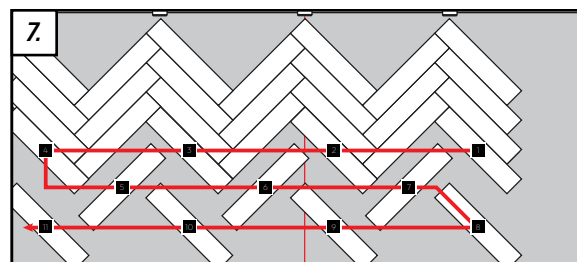
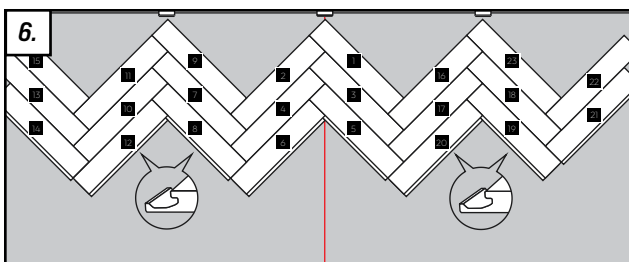

6. Push the planks against the top wall. Expand the first column along the width by adding planks in the following pattern. Add spacer blocks between the wall and the planks.
7. Expand the first row along the length by adding planks in the following pattern.

## INSTALLATION PROCEDURE - DIAGONAL LAYOUT CONTINUED

### HOW TO CUT THE PERIMETER PLANKS TO SIZE

#### ⚠ WARNING

**RISK OF INJURY!** Always wear appropriate Personal Protective Equipment (PPE), including safety goggles, dust mask and gloves when handling power tools. Always cut the flooring in a well-ventilated area.

When the full rows can no longer fit in the room, begin measuring and cutting pieces to finish the remaining sections.

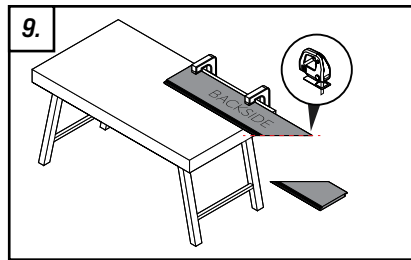
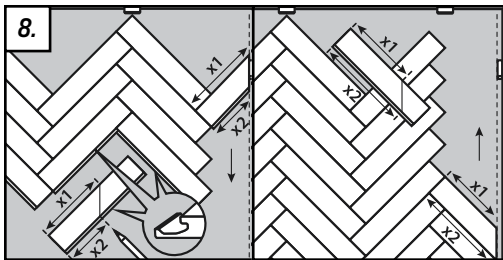

8. Measure the plank to determine the point where it needs to be cut to fit against the wall. Make sure to account for the expansion gap. Mark the plank using a pencil.
9. Clamp the plank against a workbench with the backside of the plank facing up. Use an electric saw to cut along the marked line.

### HOW TO INSTALL THE PERIMETER PLANKS

#### ⚠ WARNING

**Make sure to use the appropriate adhesive for flooring to guarantee proper bonding and durability.**

Perimeter planks should be glued to prevent them from coming loose with prolonged use.

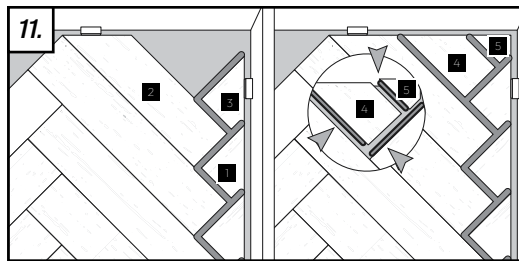
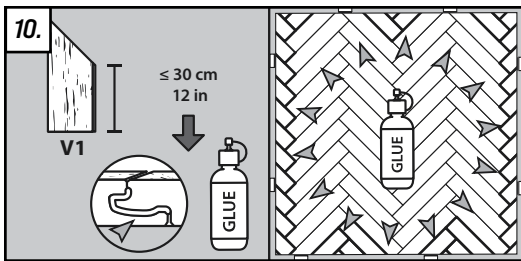

10. Attach planks shorter than 12 inch (30 cm) using glue. Apply glue to the seam, then install the plank. Immediately wipe away any excess glue to ensure a clean finish.
11. To finish the corners install each plank toward the corner. Make sure the smallest corner piece is the last piece to be installed.

INSTALLATION PROCEDURE - DIAGONAL LAYOUT CONTINUED

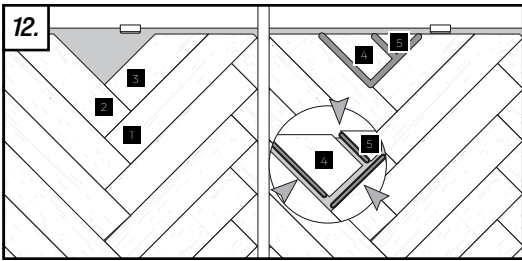

12. To finish the sides install each plank toward the wall. Make sure the smallest piece is installed last.

**Installation instructions continued on page 15**

## INSTALLATION PROCEDURE - PARALLEL LAYOUT

### HOW TO LAY THE FIRST PLANK

#### ⚠ WARNING

The flooring should be installed with planks from multiple cartons simultaneously, mixing them to achieve a balanced variation in color and shade. Check the planks for any damage prior to installation.

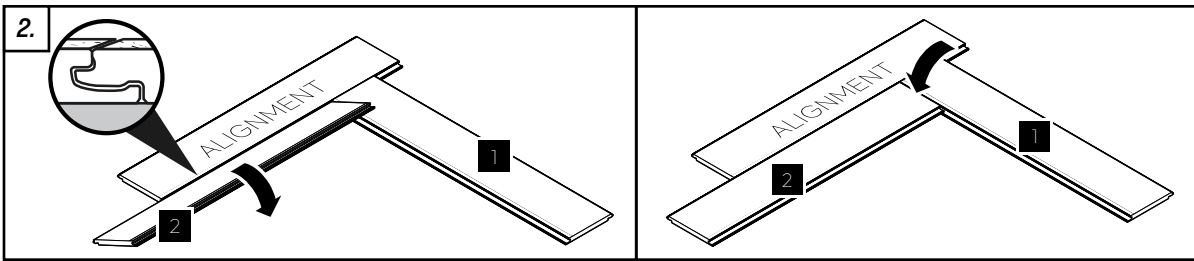
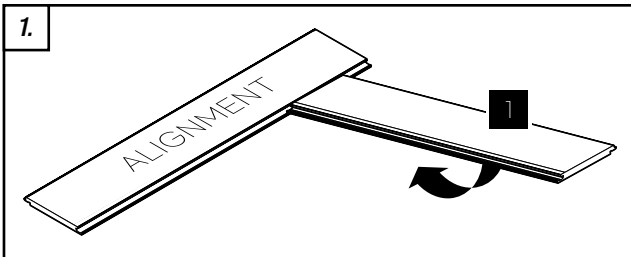

1. Click the first plank into another plank as shown in diagram above.
2. Click a second plank into position. Make sure the plank is properly pushed into the other planks.

### HOW TO START LAYING A CORNER

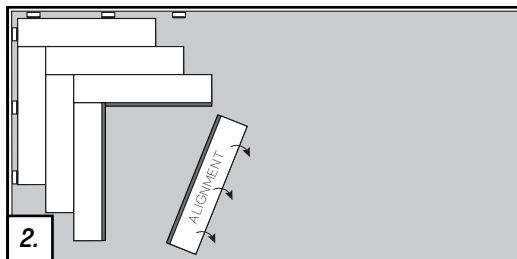
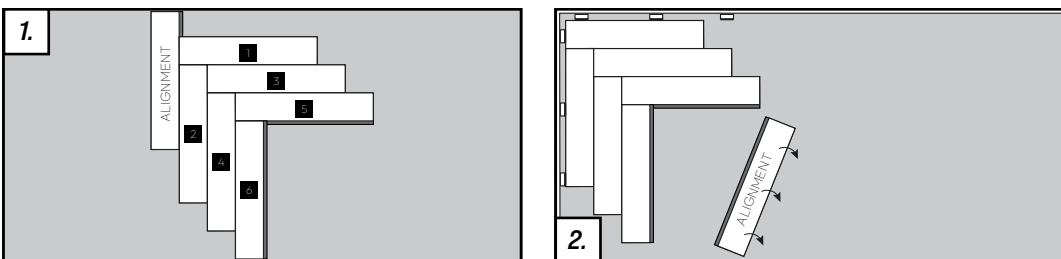

1. Click the first six planks onto an alignment plank.
2. Remove the alignment plank and push the planks into the corner of the room.  
**NOTE: Use spacer blocks to make sure there is an expansion gap.**

## INSTALLATION PROCEDURE - PARALLEL LAYOUT CONTINUED

### HOW TO CUT THE PERIMETER PLANKS TO SIZE

#### **⚠ WARNING**

**RISK OF INJURY!** Always wear appropriate Personal Protective Equipment (PPE), including safety goggles, dust mask and gloves when handling power tools. Always cut the flooring in a well-ventilated area.

When the full planks can no longer fit, begin measuring and cutting pieces to finish the remaining sections.

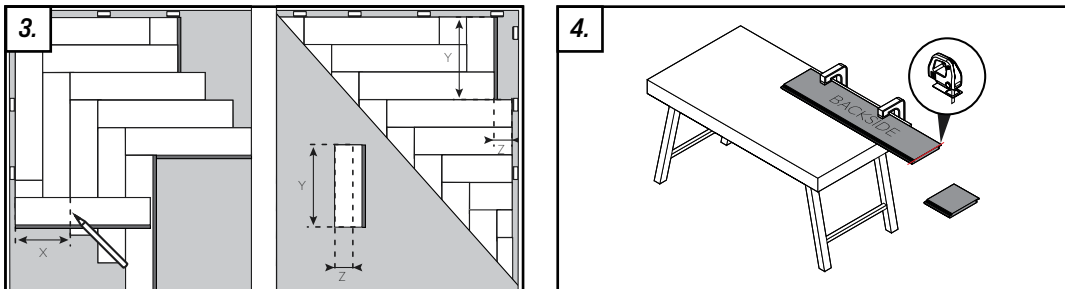

3. Put a plank on top of where the plank needs to be cut. Make sure to account for the expansion gap. Mark the plank using a pencil.
4. Clamp the plank against a workbench with the backside of the plank facing up. Use an electric saw to cut along the marked line.

### HOW TO INSTALL THE PERIMETER PLANKS

#### **⚠ WARNING**

**Make sure to use the appropriate adhesive for flooring to guarantee proper bonding and durability.**

Perimeter planks should be glued to prevent them from coming loose with prolonged use.

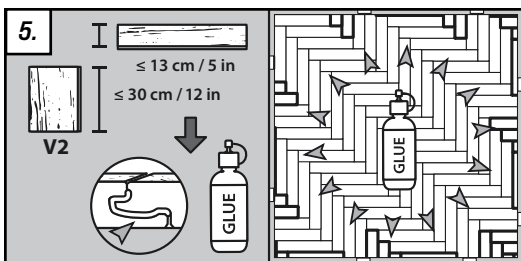

5. Attach planks shorter than 12 inch (30 cm) and narrower than 5 inch (13 cm) using glue. Apply glue to the seam, then install the plank. Immediately wipe away any excess glue to ensure a clean finish.

**Installation instructions continued on page 15**

## INSTALLING ON FLOOR IRREGULARITIES

### HOW TO INSTALL AROUND PIPES

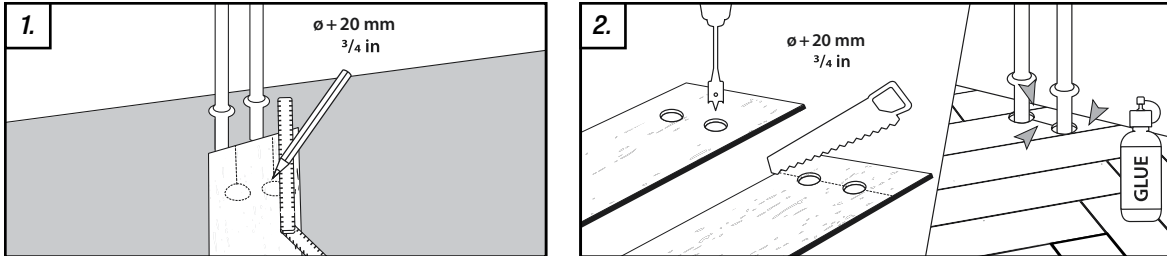

1. Measure and mark the locations on the plank where holes for pipes (or other obstructions) need to be cut out. The diameter of the holes for the pipes should be the pipe diameter plus  $\frac{3}{4}$  inch (20 mm). This will allow for sufficient clearance.
2. Use a spade bit to drill the holes. Cut away the section of the plank between the edge of the plank and the holes. Install the plank and glue down the section of the plank cut

## INSTALLING AROUND OPEN FLAME FIREPLACES

### **⚠ WARNING**

**Do not install flooring under an open flame fireplaces. This will create a fire hazard.**

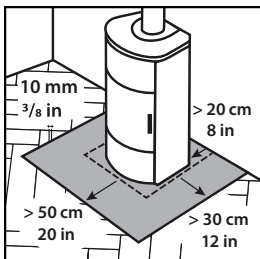

1. Install the flooring at least:
  - 20 inches (50 cm) away from the front of the open flame fireplaces.
  - 12 inches (30 cm) away from the sides of the open flame fireplaces.
  - 8 inches (20 cm) away from the back of the open flame fireplaces.
2. Use appropriate molding to transition from the flooring to the surface beneath the fireplaces for a safe and clean finish.

## RECOMMENDATIONS FOR WET AREA INSTALLATION

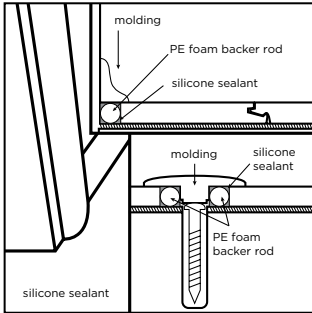

### PROCEDURE:

1. Insert compressible PE foam backer rod into room perimeter expansion space and cover completely with flexible silicone caulk.
2. Insert compressible PE foam backer rod at transitions and cover completely with flexible silicone caulk.
3. Use 100% flexible neutral cure silicone caulking around door frames and other fixed objects (e.g. plumbing).
4. Install baseboards, quarter-rounds or other applicable moldings and immediately wipe up excess caulk.
5. Ensure baseboards or quarter-rounds are attached to walls, not floors.

**Tip:** for ease of installation use PE Foam backer with a diameter closest to the floor's overall thickness.

**NOTE:** PE Foam backers are suggested as a cost-effective option to minimize the excessive use of silicone.

**NOTE:** Do not use acrylic based caulks as they are rigid and will prevent the floor from expanding and contracting. Use only neutral curing 100% flexible silicone caulk.